

ikon

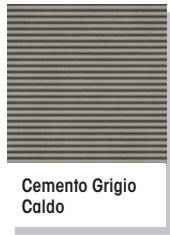

SCHEDA TECNICA - TECHNICAL FEATURES

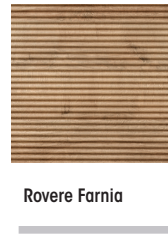
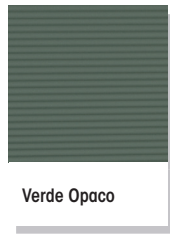
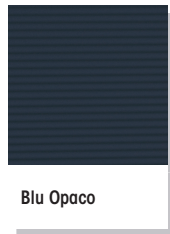
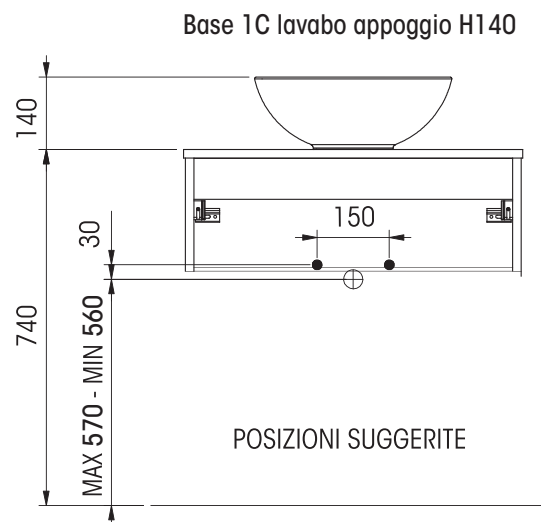
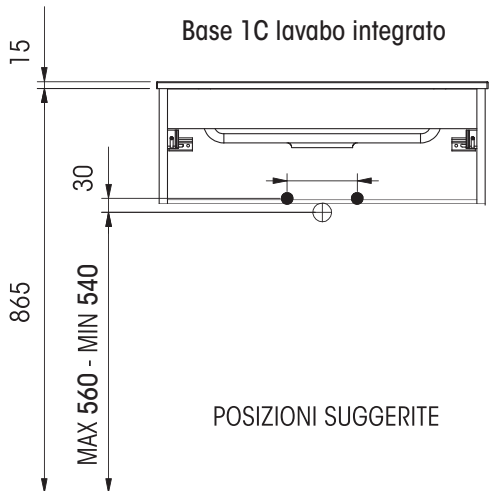
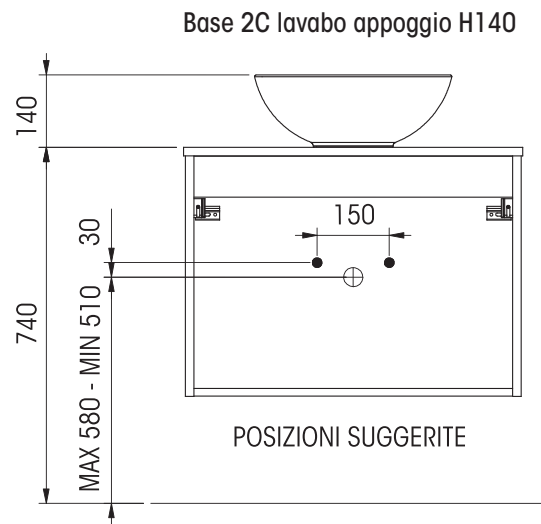
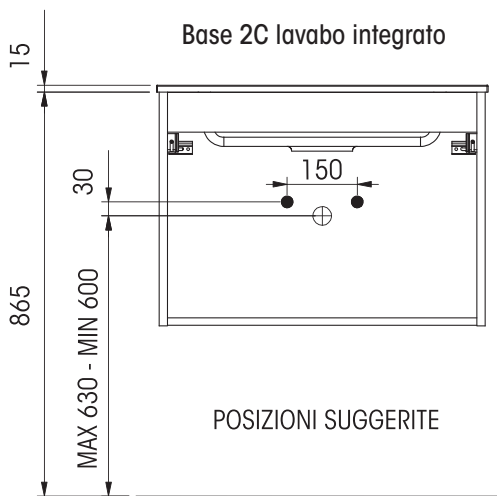

ikon

ALCUNI ESEMPI DI COMPONENTABILITA'

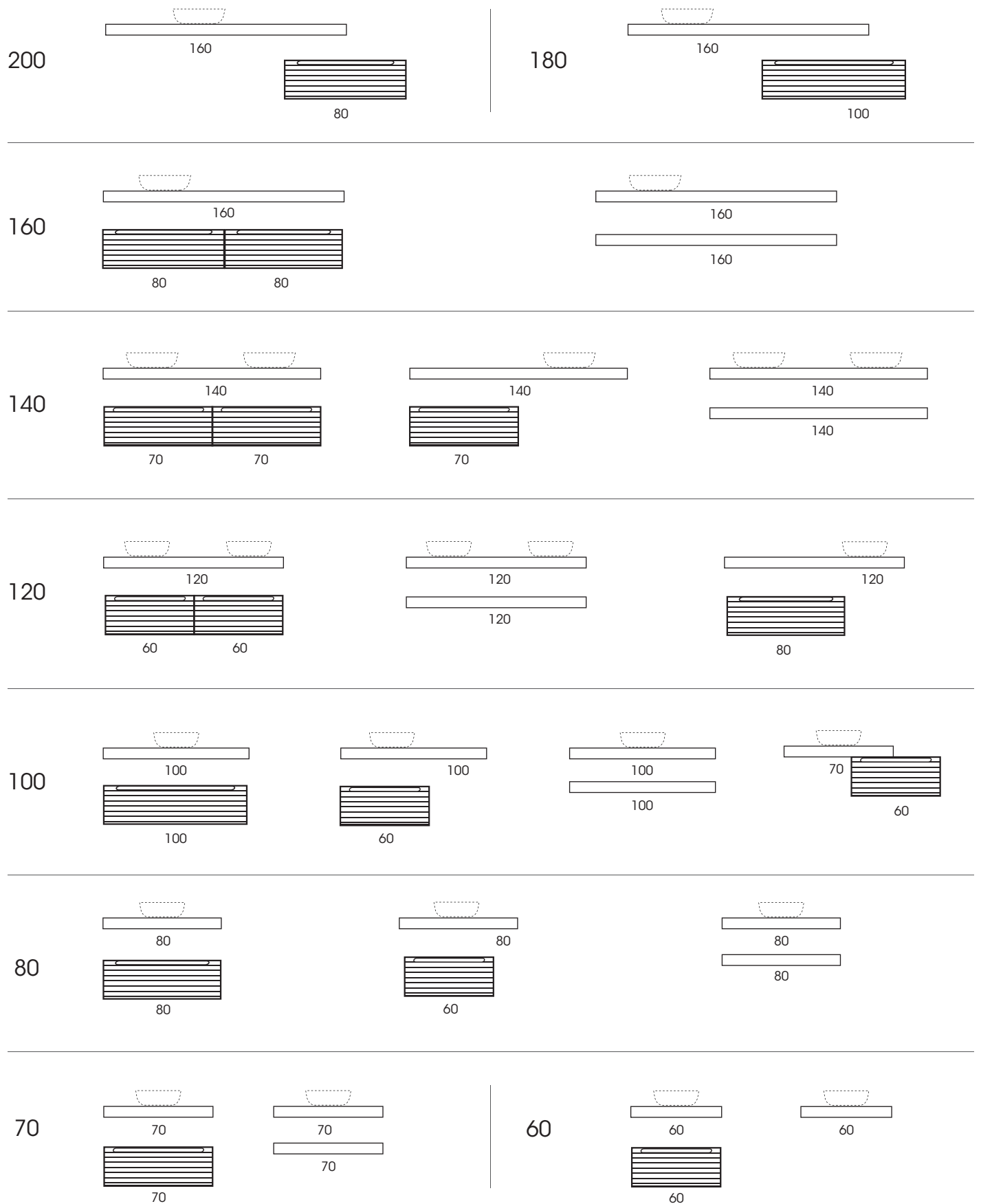

ALCUNI ESEMPI DI COMPONENTABILITA'

200

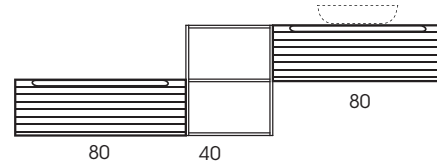
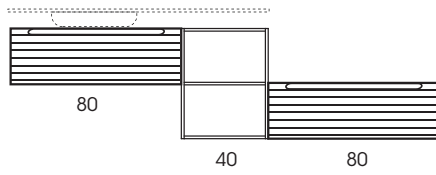

180

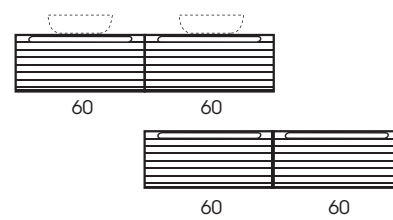
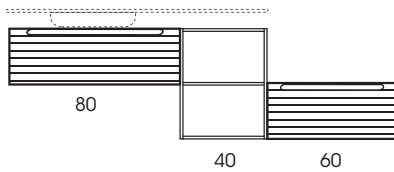

160

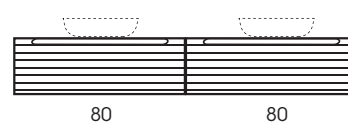
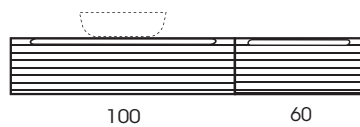
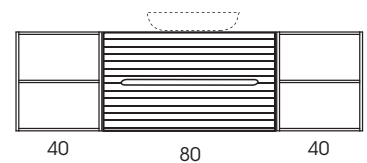
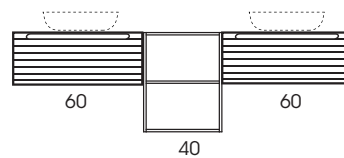
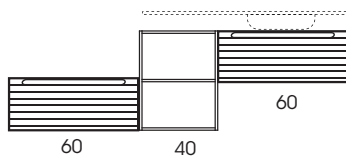
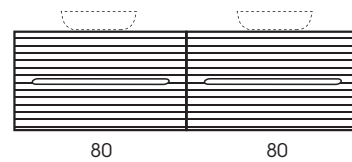
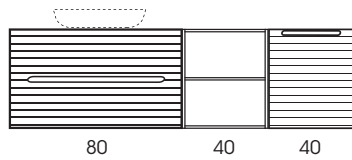

140

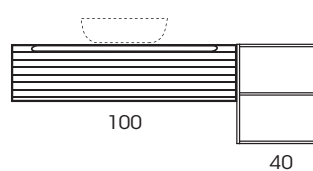
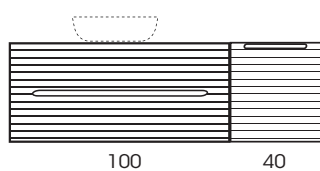
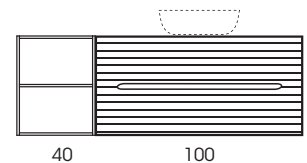
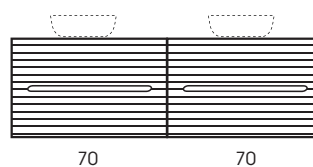
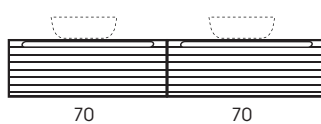

ALCUNI ESEMPI DI COMPONENTI

120

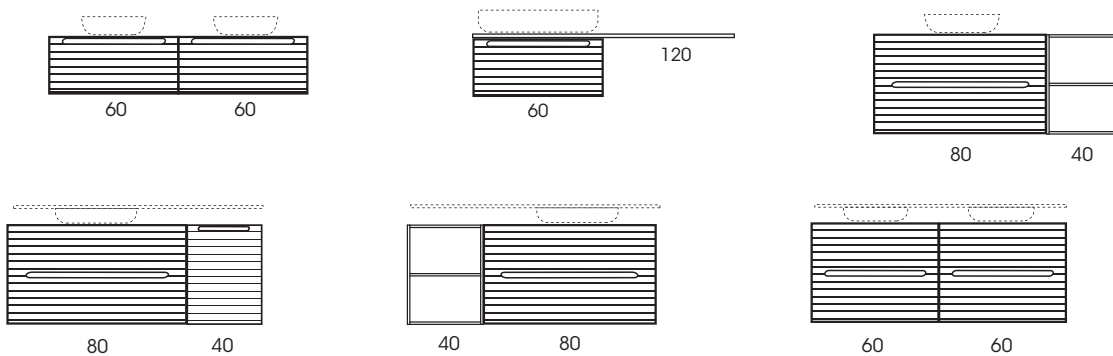

110

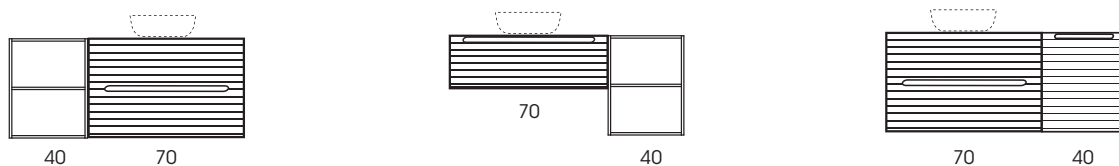

100

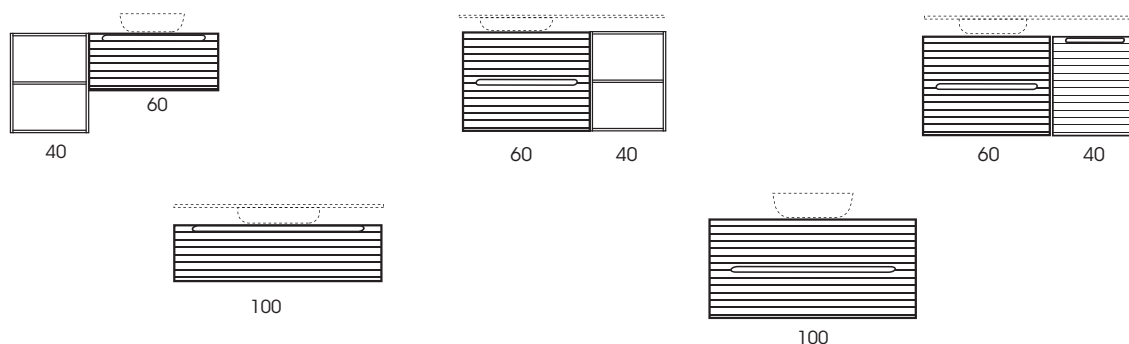

80

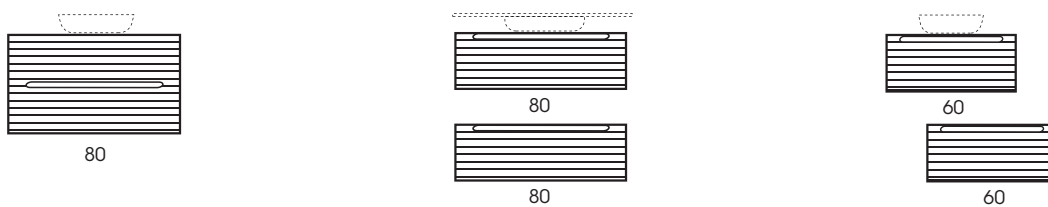

70

